

# DESIGN AND ANALYSIS OF MULTIBAND OCTAGONAL MICROSTRIP PATCH ANTENNA WITH DIFFERENT ANNULAR RING

Swagata B. Sarkar

Department of Electronics and Instrumentation Engineering, Sri Sai Ram Engineering College, India  
E-mail: swagata.b.sarkar@gmail.com

## Abstract

Microstrip patch antennas are available in different shapes and sizes. In this paper octagonal Microstrip patch antenna is designed. The octagonal patch antenna is simulated with different diameter concentric circles with improved gain. When the difference between major and minor diameter of the concentric circle improves, gain also improves. If the number of concentric circle increases the number of resonating frequency also increases. The major and minor diameter difference of 1.5mm gave the highest bandwidth of 332MHz and return loss also improved by 26.1009dB. Gain of the antenna for this new design is increased by 4dB, Band width is improved by 29.518%, and Return Loss is improved by 64.958% for the Concentric Circle 2.647/0.578. The HFSS software is used to simulate the new antenna.

## Keywords:

Bandwidth, Concentric Circle, Microstrip Octagonal Patch Antenna, Major Diameter, Minor Diameter

## 1. INTRODUCTION

Microstrip Patch antennas are low cost, flexible and highly efficient. Different shapes and sizes of Microstrip patch antennas are available in the field of communication.

In this paper a new octagonal Microstrip patch antenna is designed and analyzed with different diameter concentric circle cut. If a cut is introduced in a patch antenna, the resonating frequency of the antenna will change or multiplied. Patch without cut will give a single resonating frequency. Number of resonating frequencies will increase proportionally with the number of cut. In special cases number of cut may not be proportional to the number of resonating frequencies.

The cut will introduce multiband property to the antenna. In this work three different diameter sets of concentric circle are analyzed. In case I the octagonal Microstrip patch antenna is analyzed without any cut. In case II antenna is analyzed with a set of concentric circle cut who's minor and major axis diameter difference is 0.5mm. In case III, antenna is analyzed with a set of concentric circle cut who's major and minor axis diameter difference is 1mm. Finally in case IV, the major and minor diameter difference is taken as 2.069mm.

When the diameter difference increases it gives improved Band Width, Gain and Return loss. Gain is improved when the diameter difference is increased from 0.5mm to 2.069mm gradually. Gain increased gradually but we got improved Band width and Return Loss when the diameter difference is 2.069mm. In case of 0.5mm and 1.0mm diameter difference Band Width is very less and Loss is very high. The Microstrip Octagonal Patch antenna gave good optimized result when the major and minor diameter of the concentric circle is 2.069mm.

## 1.1 LITERATURE REVIEW

Octagonal semicircular annular ring is used for wideband antenna design. Different shapes likes pentagonal [5] [2], hexagonal antenna also designed. But improvement of return loss to 40dB is a novel approach in this paper. Metamaterial also used along with the patch to reduce ration loss. [1] [3]

## 2. DESIGN SPECIFICATIONS

The Octagonal Microstrip multiband patch antenna is designed based on square patch antenna. The four sides of the square are truncated by equilateral triangle based on fractal geometry. In fractal geometry a side is divided into three segments and middle segment is omitted either by triangular or square shape.

Here sides of the square patch are truncated by triangular shape. Octagonal Microstrip patch antenna is designed from rectangular microstrip patch antenna by fractal geometry concept. The sides of the rectangular microstrip patch antenna divided into three parts and corner parts of four sides are truncated to generate octagonal shape.

### 2.1 MATHEMATICAL MODELING FOR SQUARE PATCH ANTENNA

Width of the patch,

$$(w) = \frac{c}{2} \times \frac{1}{f_r} \times \sqrt{\frac{2}{\epsilon_r} + 1} \quad (1)$$

where,

$c$  = free space velocity of light =  $3 \times 10^{10}$  cm/sec

$f_r$  = Resonating Frequency = 5.2GHz

$\epsilon_r$  = permittivity = 4.4

Width of the patch is 17.55mm.

Effective Permittivity,

$$E_{eff} = \frac{\epsilon_r + 1}{2} + \frac{\epsilon_r - 1}{2} \times \sqrt{\left(1 + 12 \times \frac{h}{w}\right)^{-1}} \quad (2)$$

Effective permittivity is 3.874mm.

Effective length of the patch,

$$L_{eff} = \frac{c}{2} * \frac{1}{f_r} \sqrt{E_{eff}} \quad (3)$$

where,

$c$  = free space velocity of light =  $3 \times 10^{10}$  cm/sec

$f_r$  = Resonating Frequency = 5.2GHz

$E_{eff}$  = Effective permittivity = 3.874mm  
 Effective length of the patch is 14.65mm.  
 Change of Length

$$\text{Del } L = 0.412 * h * \frac{E_{eff} + 0.3}{E_{eff} - 0.258} * \frac{\frac{w}{h} + 0.264}{\frac{w}{h} + 0.8} \quad (4)$$

Change of Length is 0.7262mm.  
 Length of the patch,

$$L = L_{eff} - \text{Del } L \quad (5)$$

Length of the patch is 13.19mm.

For square patch average of length and width is taken as 15mm. For fractal antenna design one side is divided into three parts. Therefore one side of the octagon is 15mm/3 is 5mm.

Table.1. Antenna Parameters

Antenna Design parameters	Value
Resonance Frequency (Basic Square Patch)	5.2GHz
Substrate	FR4 Epoxy
Height of the patch	1.6mm
Permittivity	4.4
Length of one side of Square patch	17.55mm & 13.19mm (for rectangular patch) Theoretical
	15mm (Square patch) Practical
Length of one side of Octagonal Patch	1/3*15mm = 5mm (Fractal Geometry)

### 3. RESULTS AND DISCUSSIONS

#### 3.1 MICROSTRIP OCTAGONAL PATCH ANTENNA DESIGN

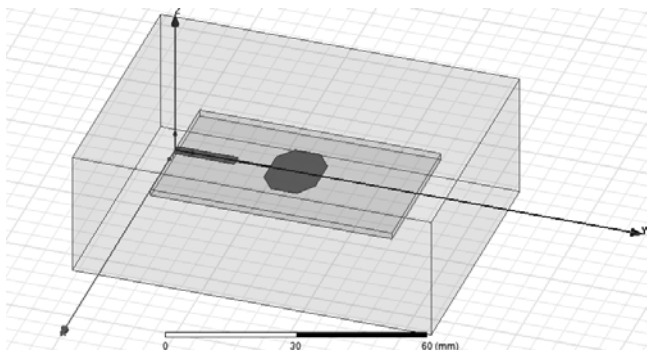

Fig.1. Design of Octagonal Microstrip Patch Antenna

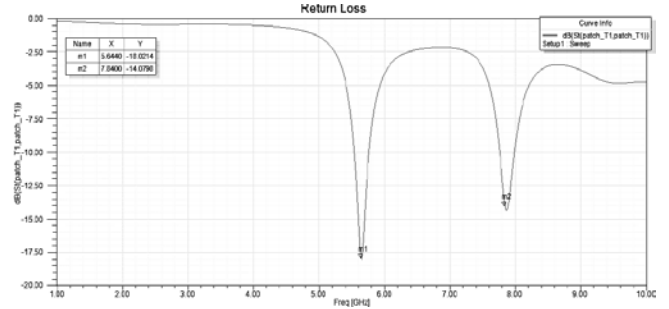

Fig.2. Return Loss of Octagonal Microstrip Patch Antenna

The octagonal shaped microstrip patch antenna of side 5mm each can generate two frequencies of 5.644GHz and 7.84GHz with return loss 18.0214 and 14.0798 respectively. Here fractal geometry is used to design the octagonal antenna. Since 1<sup>st</sup> iteration of fractal geometry is applied, so two resonance frequencies are generated.

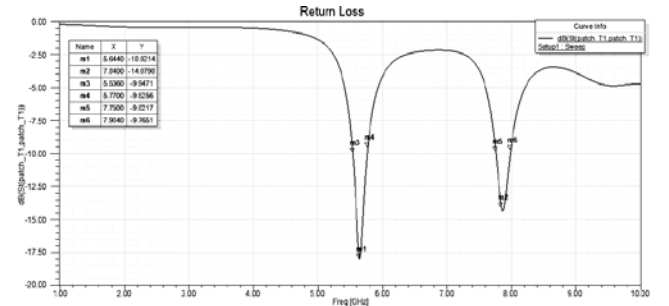

Fig.3. Band Width of Octagonal Microstrip Patch Antenna

Since two different resonance frequencies are present, bandwidth for both the frequencies are 234MHz.

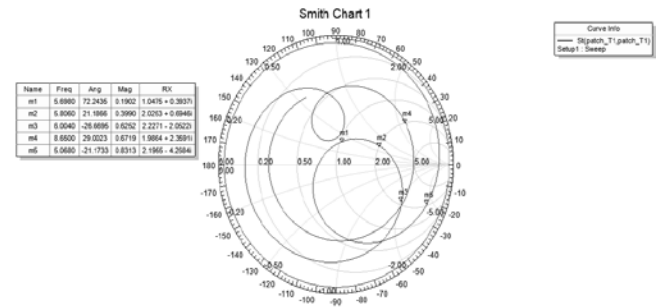

Fig.4. Smith Chart of Octagonal Microstrip Patch Antenna

The Smith Chart is the representation of resonance frequency in polar form. If two resonance frequencies are there, unit circle of the smith chart will cut for two times.

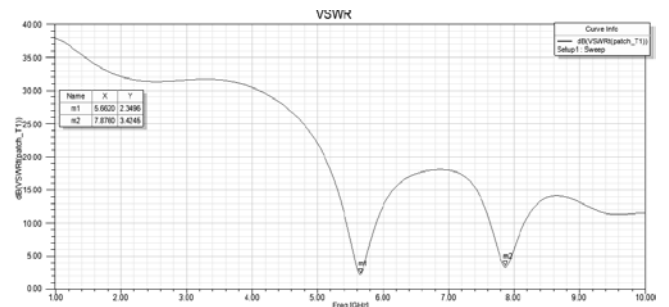

Fig.5. VSWR of Octagonal Microstrip Patch Antenna

VSWR is defined as the ratio of the maximum voltage to the minimum voltage in the standing wave. The larger the impedance mismatch, the larger the amplitude of the standing wave. A perfect impedance match would cause no voltage standing wave, so the ratio of the maximum voltage to the minimum would be 1

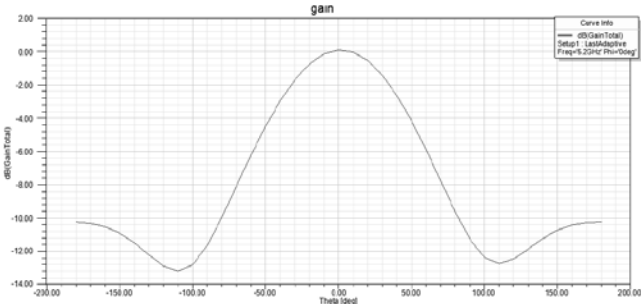

Fig.6. Gain of Octagonal Microstrip Patch Antenna

A relative measure of an antenna's ability to direct or concentrate radio frequency energy in a particular direction or pattern.

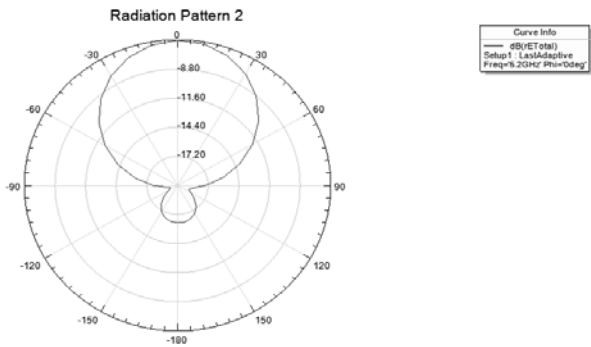

Fig.7. Radiation Pattern of Octagonal Microstrip Patch Antenna

Radiation pattern is the directional variation in intensity of the radiation from an aerial or other source.

### 3.2 MICROSTRIP OCTAGONAL PATCH ANTENNA DESIGN WITH MAJOR AXIS 1MM AND MINOR AXIS 0.5MM

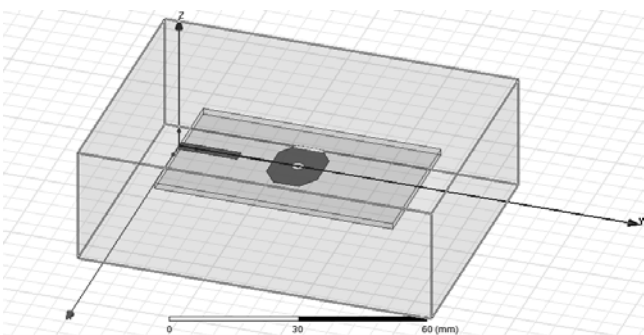

Fig.8. Design of Octagonal Microstrip Patch Antenna with 1/0.5 Annular Ring

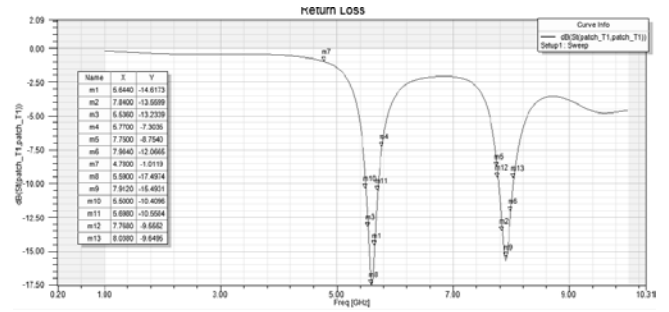

Fig.9. Return Loss and Band width of Octagonal Microstrip Patch Antenna with 1/0.5 Annular Ring

When annular ring of 1/0.5mm is introduced in the octagonal microstrip patch the resonance frequency changed to 5.59GHz and 7.912GHz respectively.

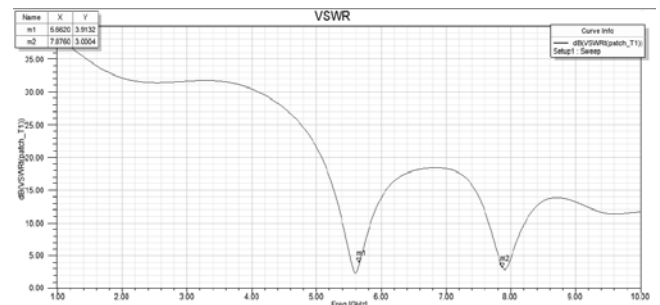

Fig.10. VSWR of Octagonal Microstrip Patch Antenna with 1/0.5 Annular Ring

VSWR also change after the introduction of annular ring.



Fig.11. Smith Chart of Octagonal Microstrip Patch Antenna with 1/0.5 Annular Ring

Smith chart values also change with the change of resonance frequency,

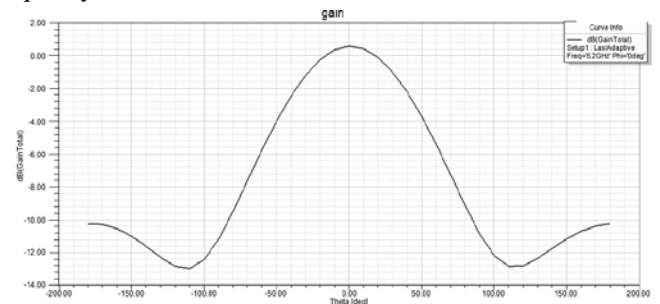

Fig.12. Gain of Octagonal Microstrip Patch Antenna with 1/0.5 Annular Ring

Gain value doesn't have much impact.

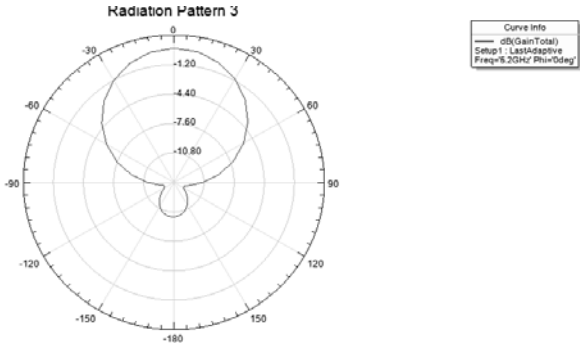

Fig.13. Radiation pattern of Octagonal Microstrip Patch Antenna with 1/0.5 Annular Ring

Radiation pattern also have minor change with the change of design.

### 3.3 MICROSTRIP OCTAGONAL PATCH ANTENNA DESIGN WITH MAJOR AXIS 3.5MM AND MINOR AXIS 2.5MM

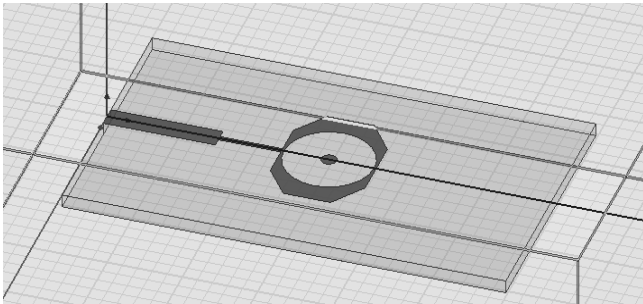

Fig.14. Design of Octagonal Microstrip Patch Antenna with 3.5/2.5 Annular Ring

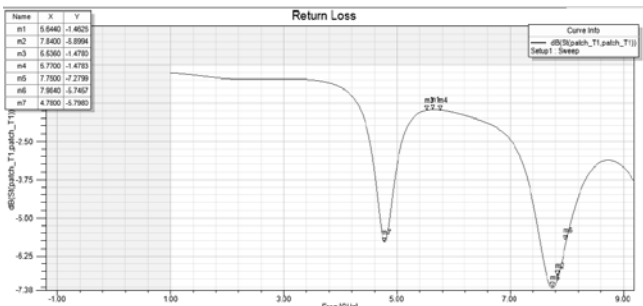

Fig.15. Return Loss and Band width of Octagonal Microstrip Patch Antenna with 3.5/2.5 concentric circle

If the diameter of annular ring increased resonance frequencies are decreased to 4.78GHz and 7.75GHz respectively.

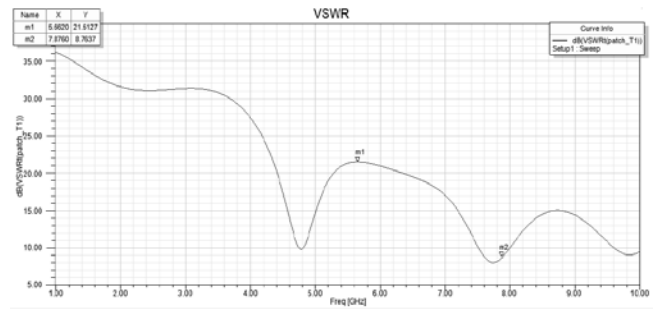

Fig.16. VSWR of Octagonal Microstrip Patch Antenna with 3.5/2.5 Annular Ring

VSWR value also changed accordingly.



Fig.17. Smith chart of Octagonal Microstrip Patch Antenna with 3.5/2.5 Annular Ring

Smith Chart gives the value based on resonance frequency.

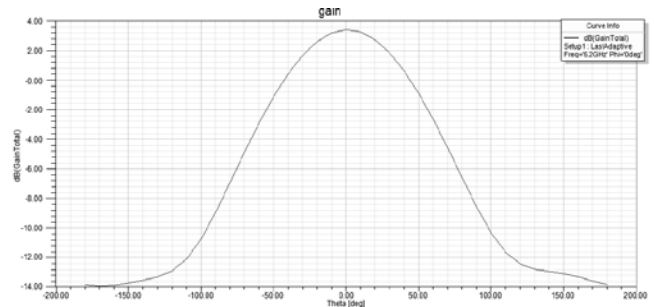

Fig.18. Gain of Octagonal Microstrip Patch Antenna with 3.5/2.5 Annular Ring

Gain only improved to a certain limit.

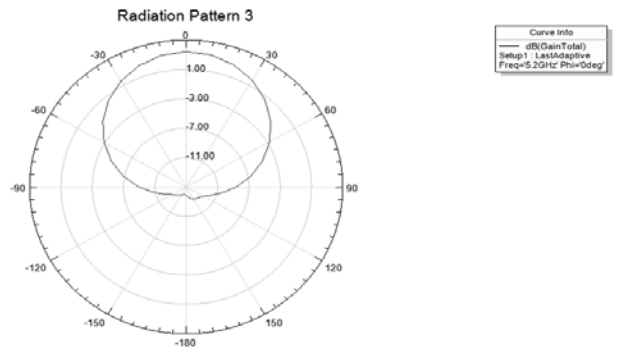

Fig.19. Radiation pattern of Octagonal Microstrip Patch Antenna with 3.5/2.5 concentric circle

### 3.4 MICROSTRIP OCTAGONAL PATCH ANTENNA DESIGN WITH MAJOR AXIS 2.647MM AND MINOR AXIS 0.578MM

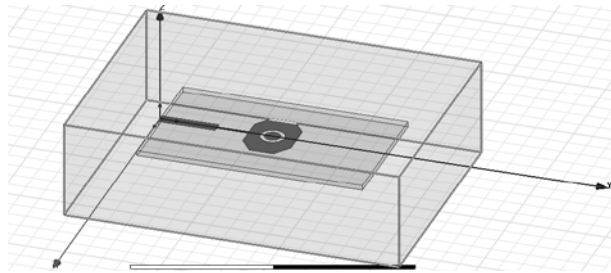

Fig.20. Design of Octagonal Microstrip Patch Antenna with 2.647/0.578 Annular Ring

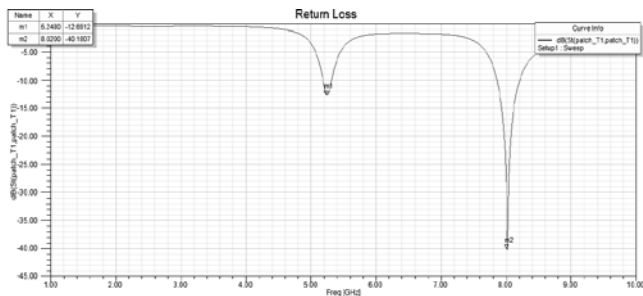

Fig.21. Return Loss of Octagonal Microstrip Patch Antenna with 2.647/0.578 Annular Ring

With 2.647/0.578mm annular ring only very good return loss of 40dB obtained at 8.02GHz. 12dB return loss obtained for 5.248GHz.

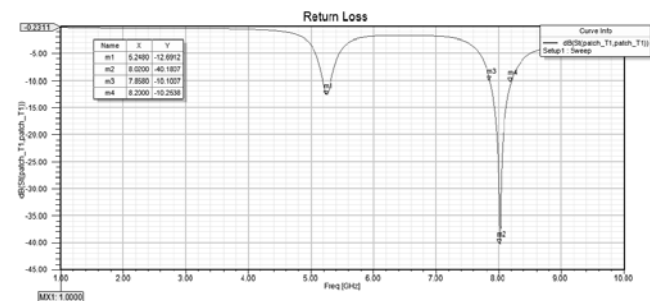

Fig.22. Band width of Octagonal Microstrip Patch Antenna with 2.647/0.578 Annular Ring

VSWR also increased accordingly. Bandwidth is increased from 234MHz to 332MHz.

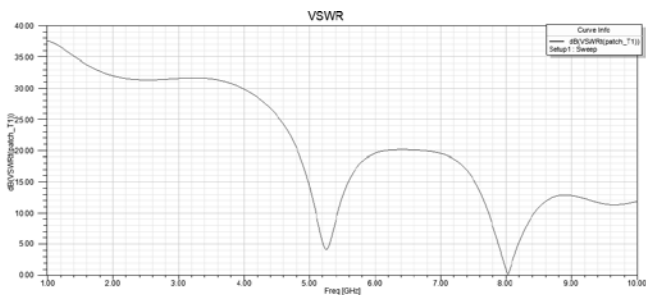

Fig.23. VSWR of Octagonal Microstrip Patch Antenna with 2.647/0.578 Annular Ring



Fig.24. Smith Chart of Octagonal Microstrip Patch Antenna with 2.647/0.578 Annular Ring

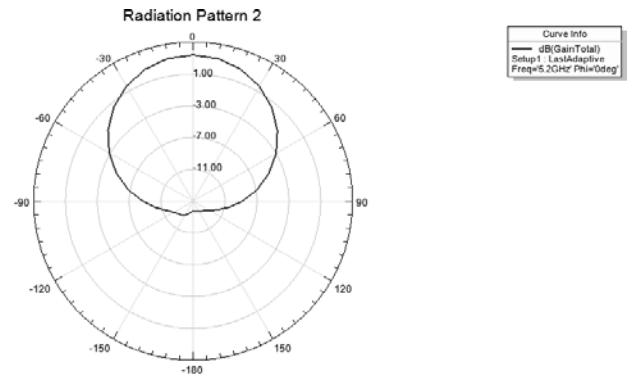

Fig.25. Radiation Pattern of Octagonal Microstrip Patch Antenna with 2.647/0.578 Annular Ring

Radiation pattern is also improved ideally without any back lobe.

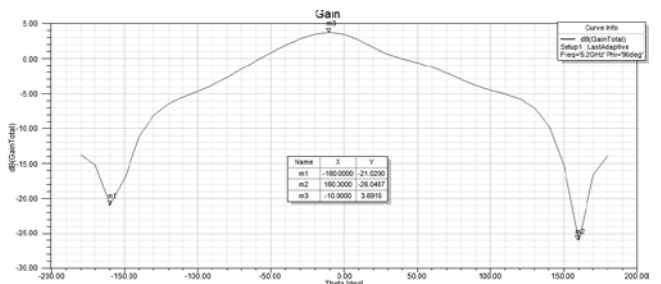

Fig.26. Gain of Octagonal Microstrip Patch Antenna with 2.647/0.578 Annular Ring

Gain improved from 0dB to 4dB.

Table.2. Comparative result Analysis for multiband Octagonal Microstrip Patch Antenna with different Concentric Circle cut

Types of Antenna	Resonance Frequency (GHz)	Gain (dB)	Band Width (MHz)	S11	Return Loss (dB)
Octagonal Microstrip patch antenna	5.6640 7.8400	0	234	-18.021 <b>-14.079</b>	18.0214 <b>14.0798</b>
Octagonal Microstrip patch antenna with 1/0.5 Concentric Circle	5.5900 7.9120	0.6	198	-17.497 -15.493	-17.4974 -15.4931

Octagonal Microstrip patch antenna with 3.5/2.5 Concentric Circle	4.7800 7.9840	3.5	-	-5.7980 -5.7457	-5.7980 -5.7457
Octagonal Microstrip patch antenna with 2.647/0.578 Concentric Circle	5.2480 8.0200	4	332	-12.691 <b>-40.181</b>	-12.691 <b>-40.181</b>

Gain of the antenna for this new design is increased by 4 dB, Band width is improved by 29.518%, Return Loss is improved by 64.958% for the Concentric Circle 2.647/0.578. Therefore the optimized value is achieved when concentric circle diameter is 2.647/0.578.

#### 4. CONCLUSION

In this paper a new Multiband Octagonal Microstrip Patch Antenna is designed which can be used within the frequency range of 5.2480GHz to 8.02GHz. But all the intermediate frequencies are not efficient. The gain and return loss is improved at 8.02GHz frequency. The Gain, Return loss and Band width are improved by 4dB, 64.958% and 29.518%.

#### REFERENCES

- [1] J.G. Joshi, S.S. Pattnaik, S. Devi, M.R. Lohokare and Chintakindi Vidyasagar, "Offset Fed Diamond Shaped Split Ring (DSSR) Planar Metamaterial Antenna", *Proceedings of Applied Electromagnetics Conference*, pp. 1-4, 2009.
- [2] Bimal Garg, Nitin Agrawal, Vijay Sharma, Ankita Tomar and Prashant Dubey, "Rectangular Microstrip Patch Antenna with Pentagonal Rings Shaped Metamaterial Cover", *Proceedings of International Conference on Communication Systems and Network Technologies*, pp. 40-44, 2012.
- [3] Shobhit K. Patel and Y.P. Kosta, "S-Shape Meandered Microstrip Patch Antenna Design using Metamaterial", *Proceedings of IEEE Antennas and Propagation Society International Symposium*, pp. 547-548, 2014.
- [4] N. Ripin, W.M.A.W. Saïdy, A.A. Sulaiman, N.E.A. Rashid and M.F. Hussin, "Miniaturization of Microstrip Patch Antenna through Metamaterial Approach", *Proceedings of IEEE Student Conference on Research and Development*, pp. 365-369, 2013.
- [5] Galaba Sai Rajesh, K. Venkata Kishore and Vijay Kumar, "Multiband Microstrip Patch Antenna Design using Metamaterial for Airborne SAR System", *Proceedings of IEEE Conference on Signal Processing, Informatics, Communication and Energy Systems*, pp. 1-3, 2015.
- [6] Douglas H. Werner and Suman Ganguly, "An Overview of Fractal Antenna Engineering Research", *IEEE Transactions on Antennas and Propagation*, Vol. 45, No. 1, pp. 38-57, 2003.